

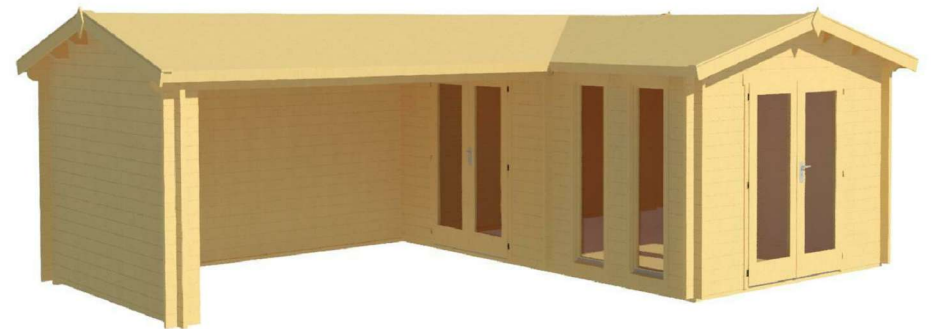

Parakenings 40 (680x480)

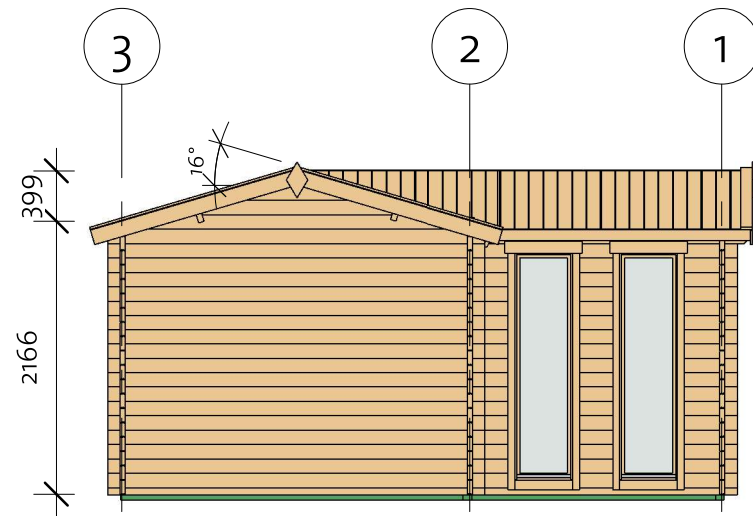
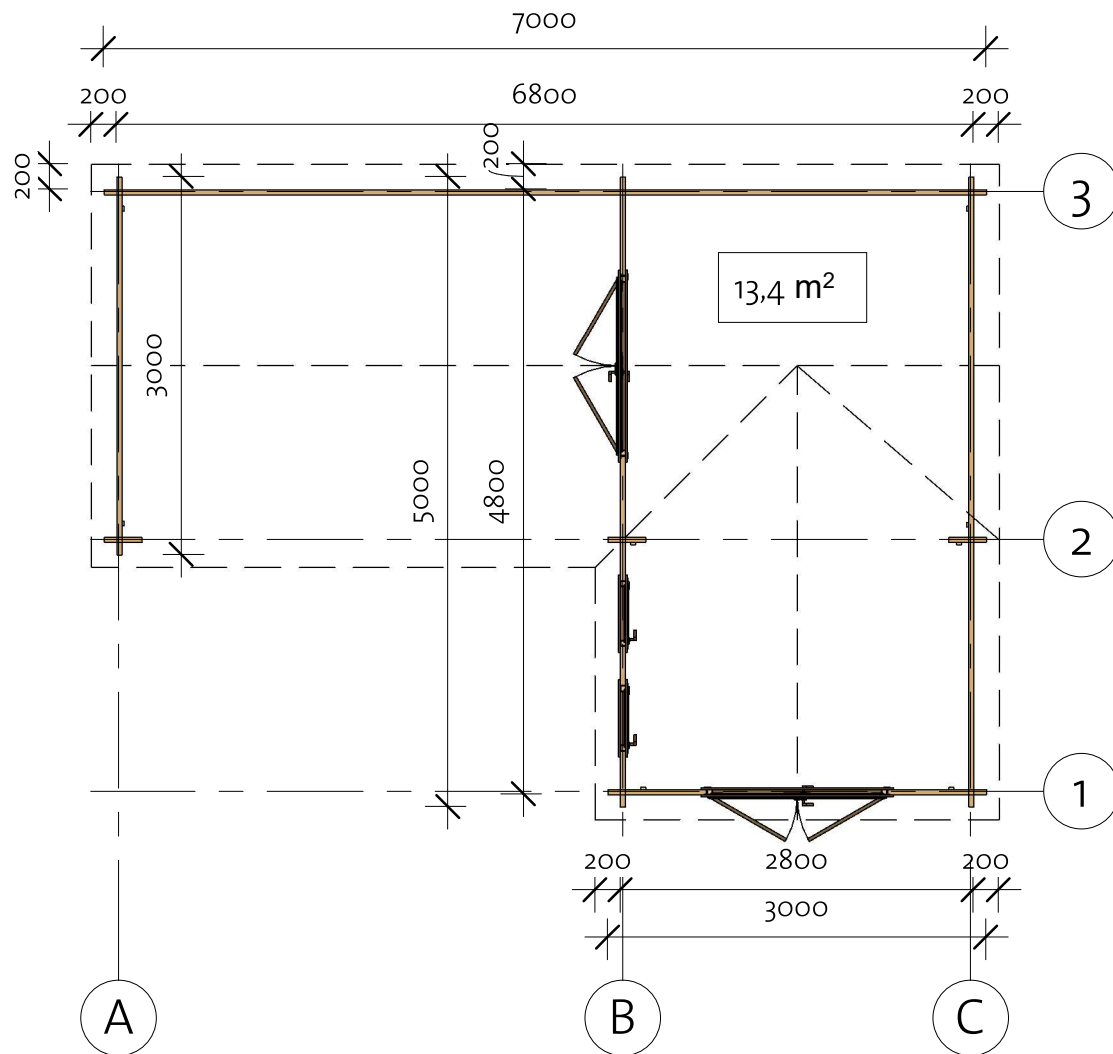
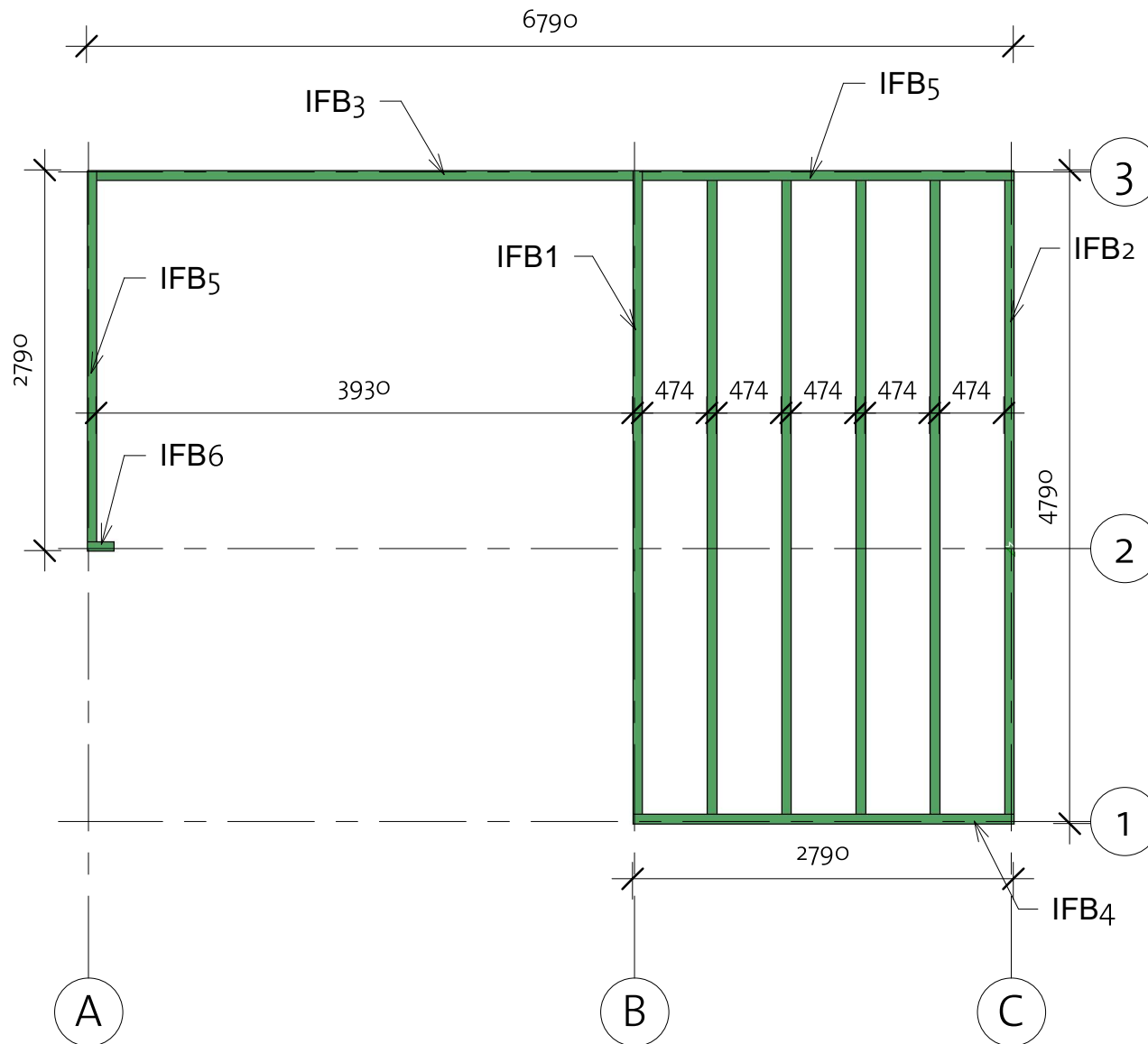

Parakenings 40 (680x480)

Foundation



Impregnated foundation beams				
Mark	Type	Profile	Count	Length
IFB1	IFB 70x40		1	4720
IFB2	IFB 70x40		5	4650
IFB3	IFB 70x40		1	3930
IFB4	IFB 70x40		1	2790
IFB5	IFB 70x40		2	2720
IFB6	IFB 70x40		1	195



Parakenings 40 (680x480)

Floor Plan

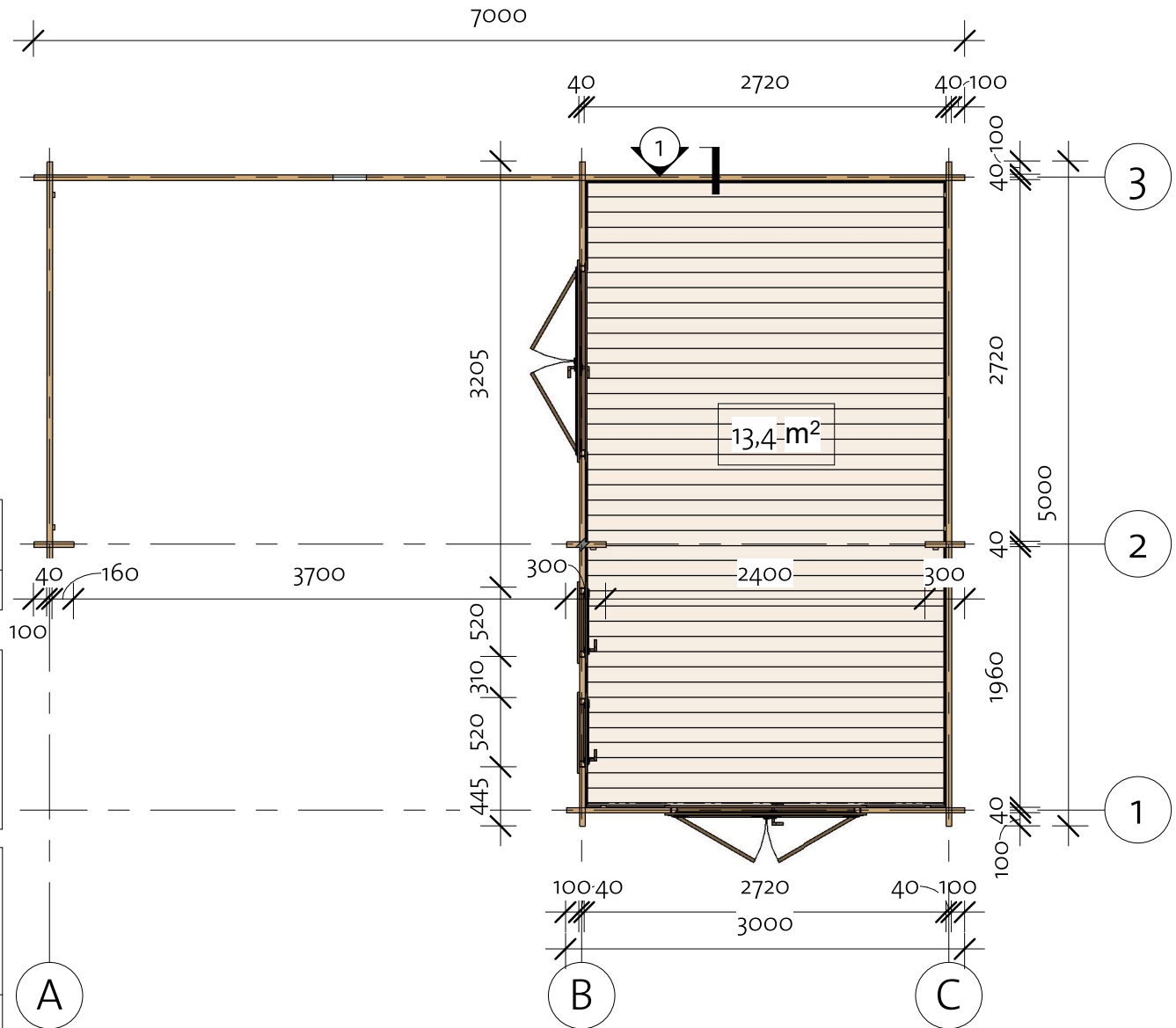
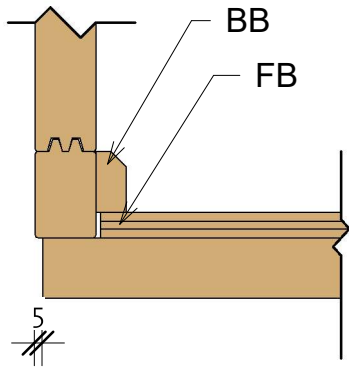
① Baseboard



Floor Schedule

Mark	Type	Profile	Count	Length
FB	FB 17x114		42	2714
BB1	BB 20x40		2	2800
BB2	BB 20x40		2	5000

200420

Parakenings 40 (680x480)

Wall 1

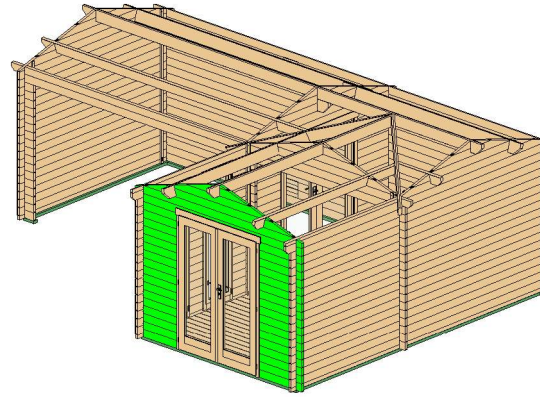

Wall 1			
Mark	Profile	Count	Cut Length

1LG-1 *	40x51	1	360
1LG-2	40x114	34	780
1LG-3 *	40x114	1	1142
1LG-4 *	40x114	1	1930
1LG-5 *	40x114	1	2719
1LG-6	40x114	1	3000
1LG-7 *	40x114	1	3000

* Gable - delivered premounted

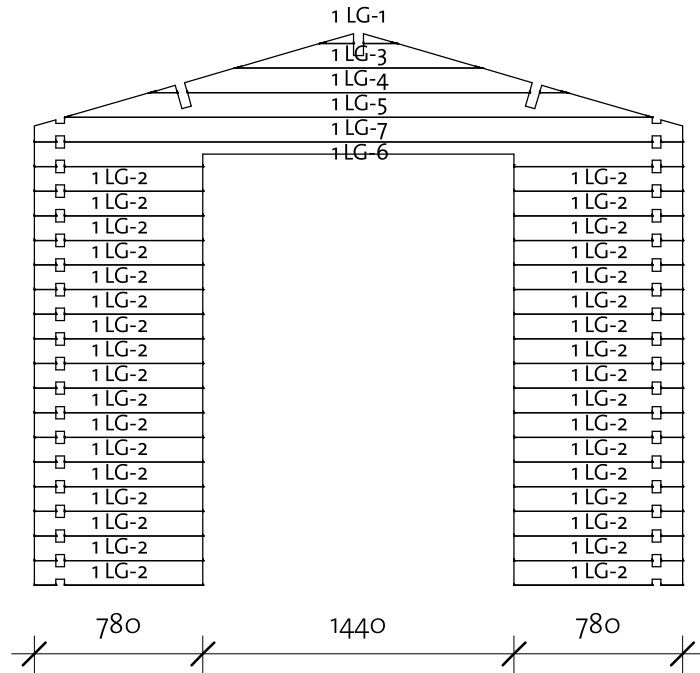

Log Profile Wall 1	
Profile	Profile



40x51	
40x114	

Parakenings 40 (680x480)

Wall 2

Log Profile Wall 2	
Profile	Profile

Log Profile Wall 2	
Profile	Profile

40X51	
40X114	

40X114	
--------	---

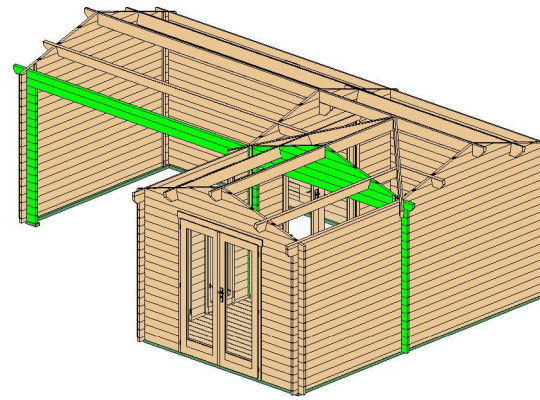

Wall 2			
Mark	Profile	Count	Cut Length

2LG-1 *	40X51	1	360
2LG-2	40X114	34	300
2LG-3 *	40X114	1	1142
2LG-4 *	40X114	1	1930
2LG-5 *	40X114	1	2719
2LG-6	40X114	1	2880
2LG-7 *	40X114	1	2720
2LG-8	40X114	1	4120
2LG-9	40X114	15	400
2LG-10	40X114	2	400
2TL-1	40X114	1	4200
2TL-2	40X114	1	203

* Gable - delivered premounted

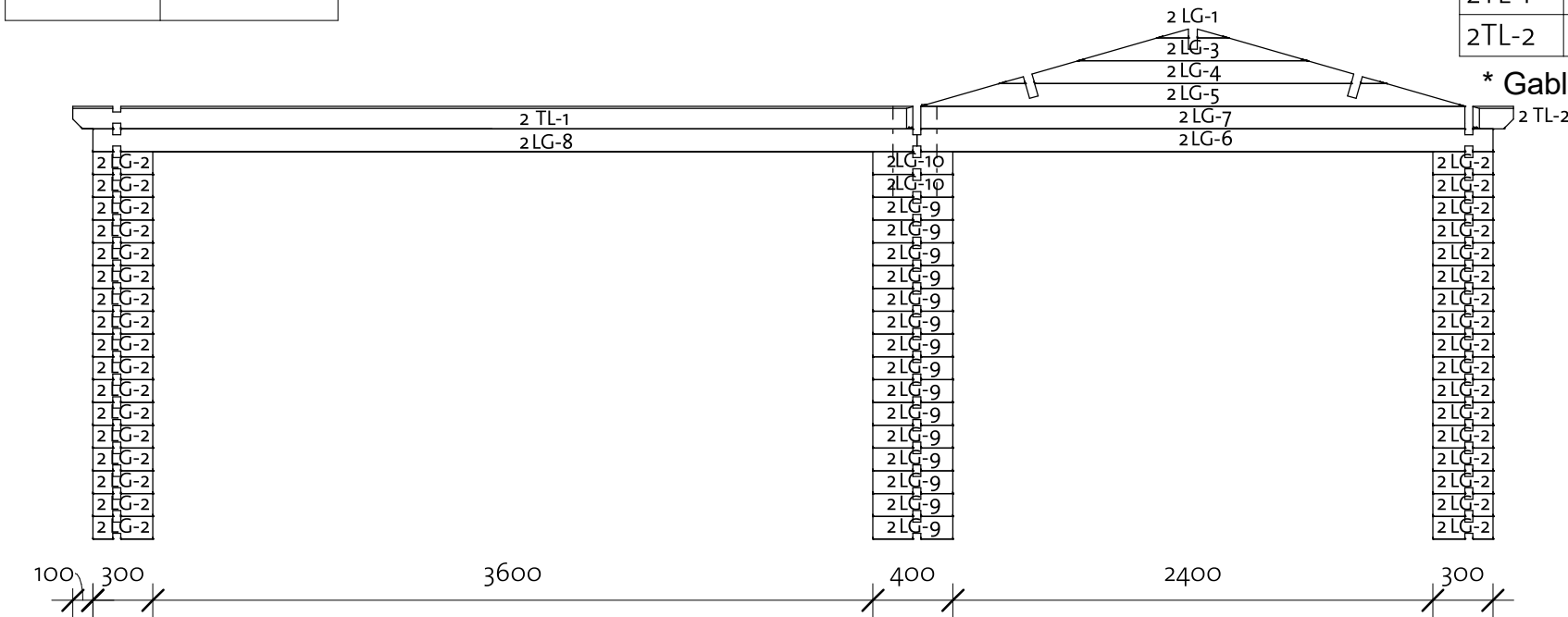

200413

Parakenings 40 (680x480)

Wall 3

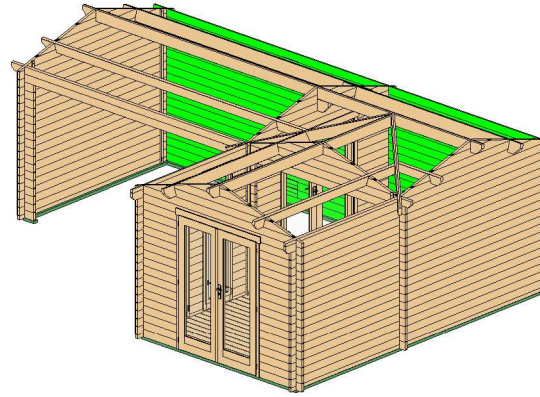

Wall 3			
Mark	Profile	Count	Cut Length

3LG-1	40X114	12	2880
3LG-2	40X114	7	4120
3LG-3	40X114	6	4750
3LG-4	40X114	6	2500
3LG-5	40X114	5	4120
3TL-1	40X114	1	2983
3TL-2	40X114	1	4220

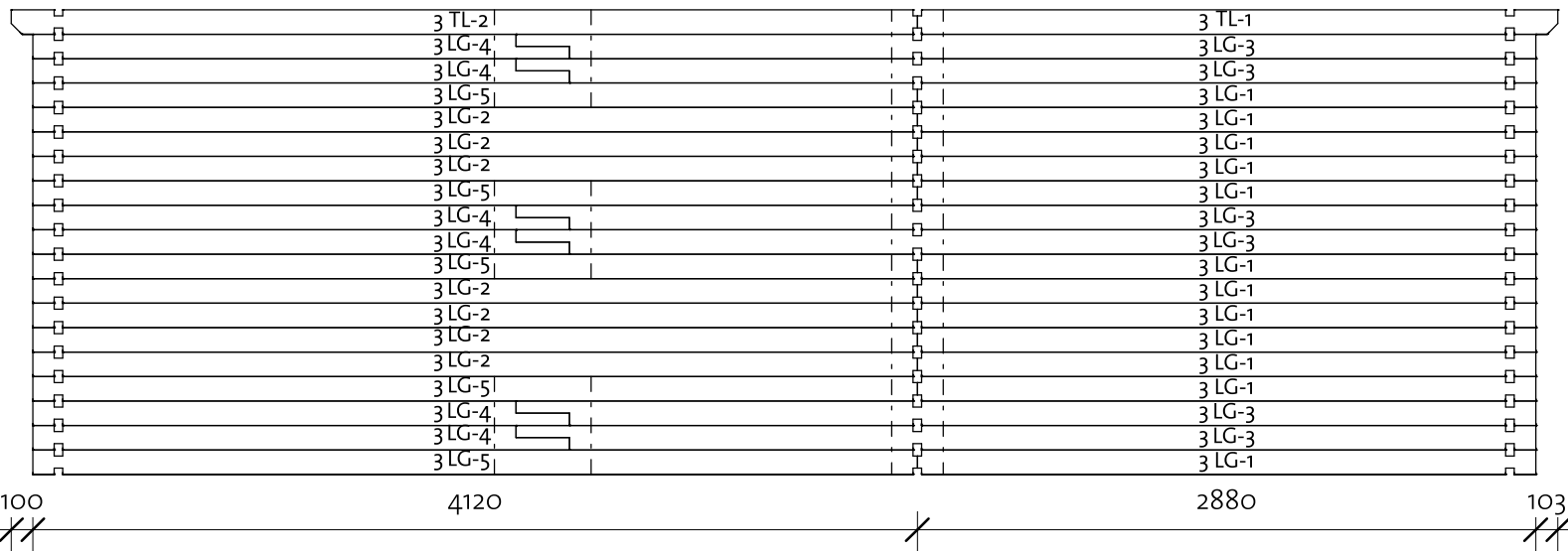

Log Profile Wall 3	
Profile	Profile

40X114	
40X114	

100

4120

2880

103

200415

Parakenings 40 (680x480)

Wall A

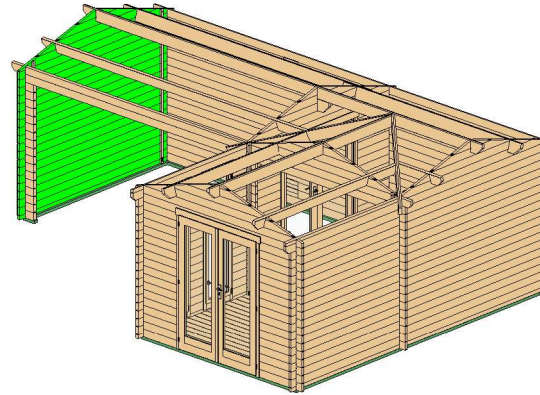



Wall A			
Mark	Profile	Count	Cut Length

ABL-1	40x57	1	3000
ALG-1*	40x114	1	779
ALG-2*	40x114	1	1556
ALG-3*	40x114	1	2332
ALG-4	40x114	18	3000
ALG-5*	40x114	1	3000

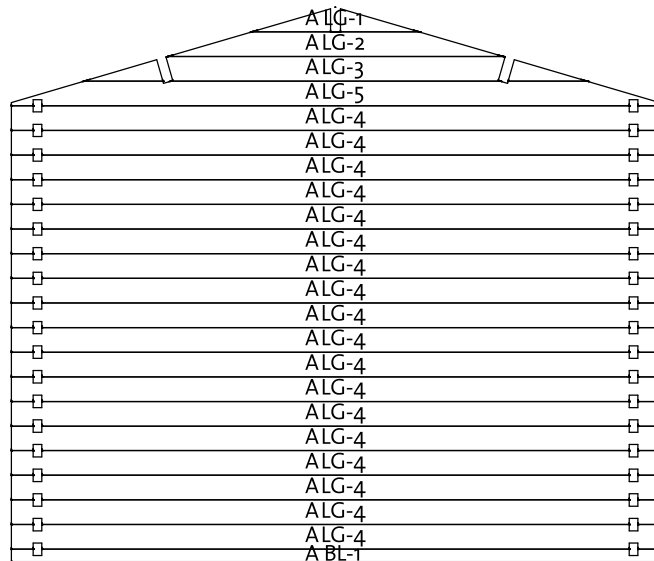
* Gable - delivered premounted





Log Profile Wall A	
Profile	Profile

40x57	
40x114	

Parakenings 40 (680x480)

Wall B

Log Profile Wall B	
Profile	Profile

40x57	
40x57	

Log Profile Wall B	
Profile	Profile

40x114	
--------	---

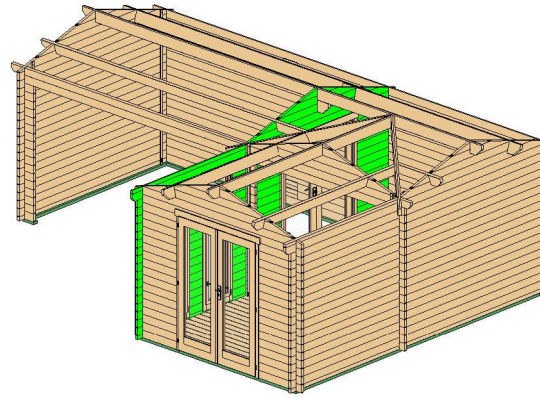

Wall B			
Mark	Profile	Count	Cut Length

BBL-1	40x57	1	780
BBL-2	40x57	1	2780
BLG-1	40x114	17	310
BLG-2	40x114	17	445
BLG-3 *	40x114	1	779
BLG-4	40x114	17	780
BLG-5	40x114	17	985
BLG-6 *	40x114	1	1519
BLG-7 *	40x114	1	2332
BLG-8 *	40x114	1	2868
BLG-9	40x114	1	5100
BTL-1	40x57	1	2208

* Gable - delivered premounted

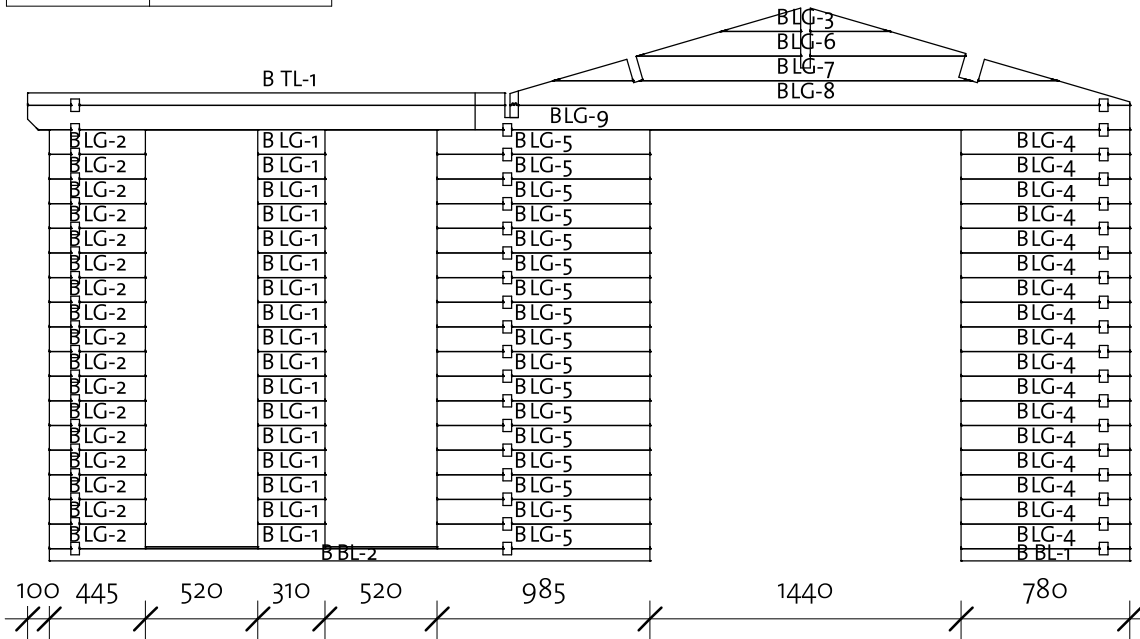

Parakenings 40 (680x480)

Wall C

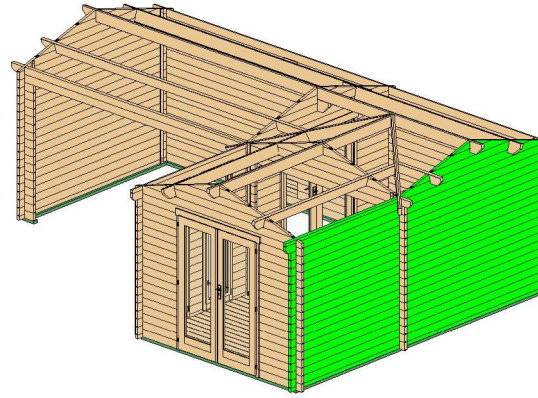

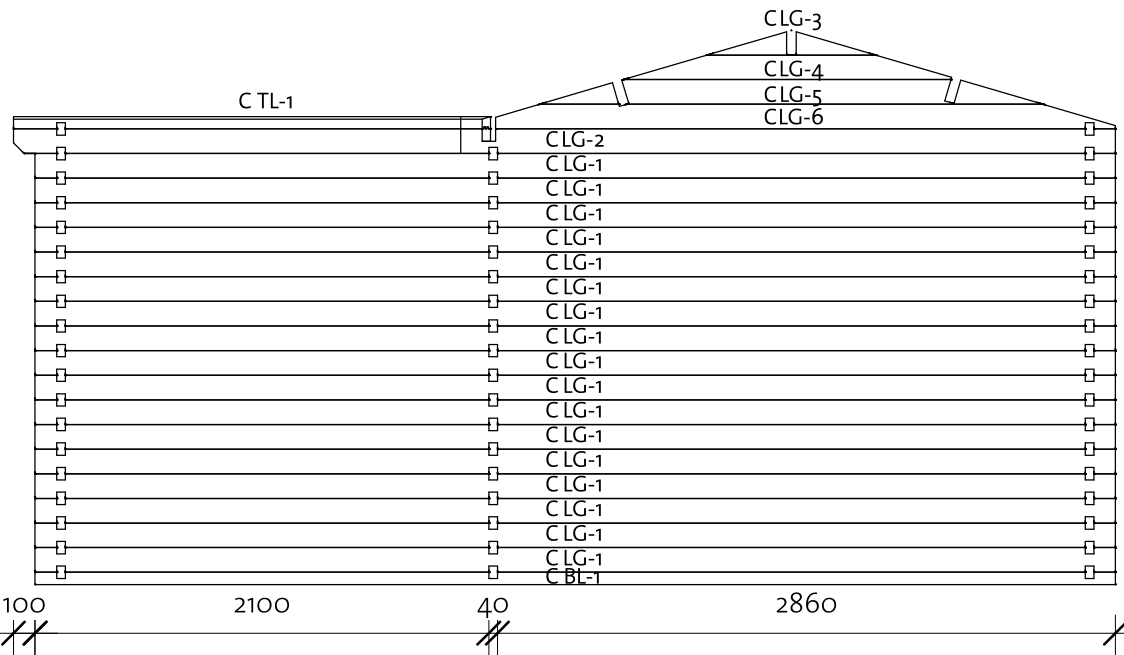

Wall C			
Mark	Profile	Count	Cut Length
CBL-1	40x57	1	5000
CLG-1	40x114	17	5000
CLG-2	40x114	1	5100
CLG-3*	40x114	1	779
CLG-4*	40x114	1	1519
CLG-5*	40x114	1	2332
CLG-6*	40x114	1	2868
CTL-1	40x57	1	2208

* Gable - delivered premounted



Log Profile Wall C

Profile Profile

40x57	
40x57	
40x114	

Parakenings 40 (680x480)

Roof 1

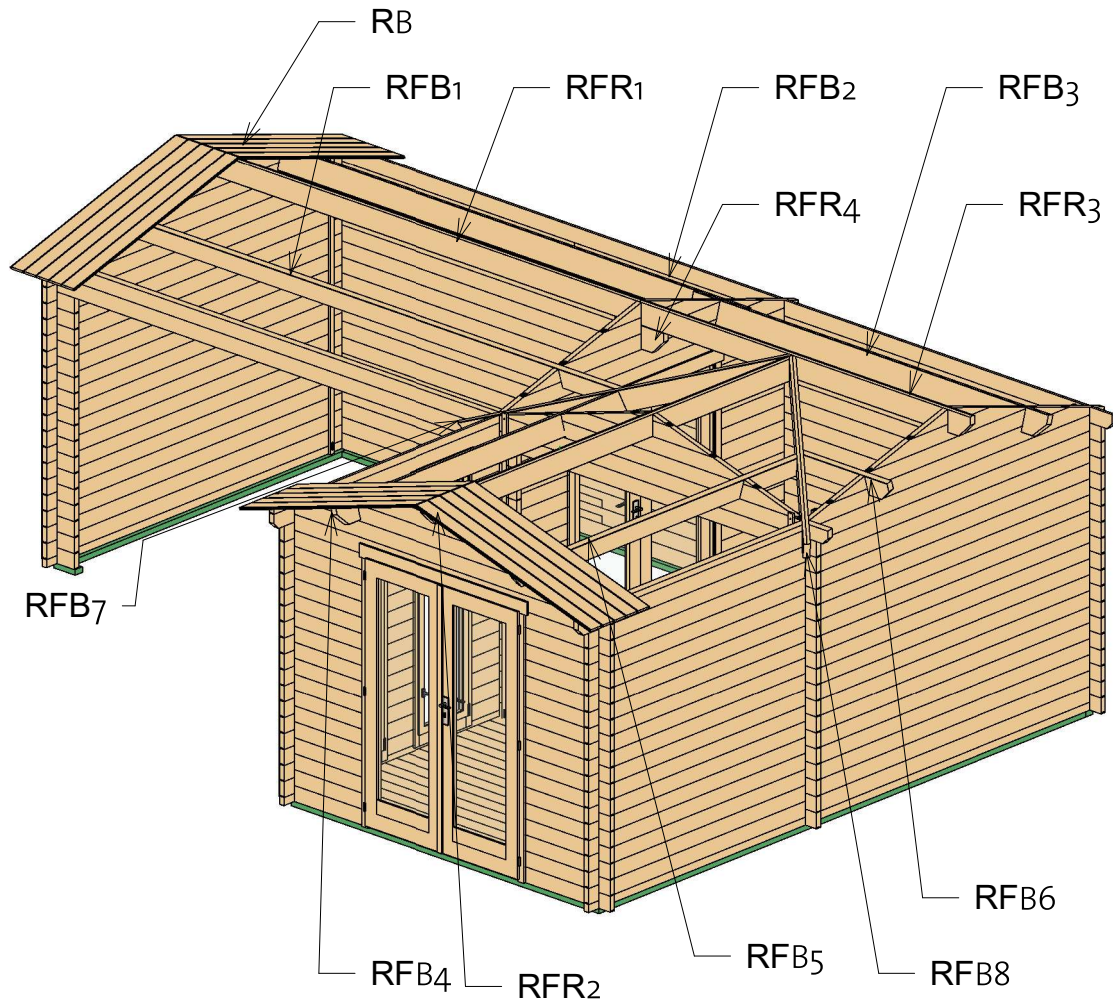

Roof				
Mark	Type	Profile	Count	Cut Length
RFB1	Beam 45x155		1	4837
RFB2	Beam 45x170		1	4440
RFB3	Beam 45x170		1	3203
RFB4	Beam 45x155		1	2796
RFB5	Beam 45x155		1	2796
RFB6	Beam 45x155		1	840
RFB7	45x160		1	2254
RFB8	45x160		1	2254
RFR1	Ridge 45x170		1	4220
RFR2	Ridge 45x165		1	3547
RFR3	Ridge 45x170		1	2983
RFR4	Ridge 45x170		1	440

Parakenings 40 (680x480)

Roof 2

① Plan for mounting roofboards

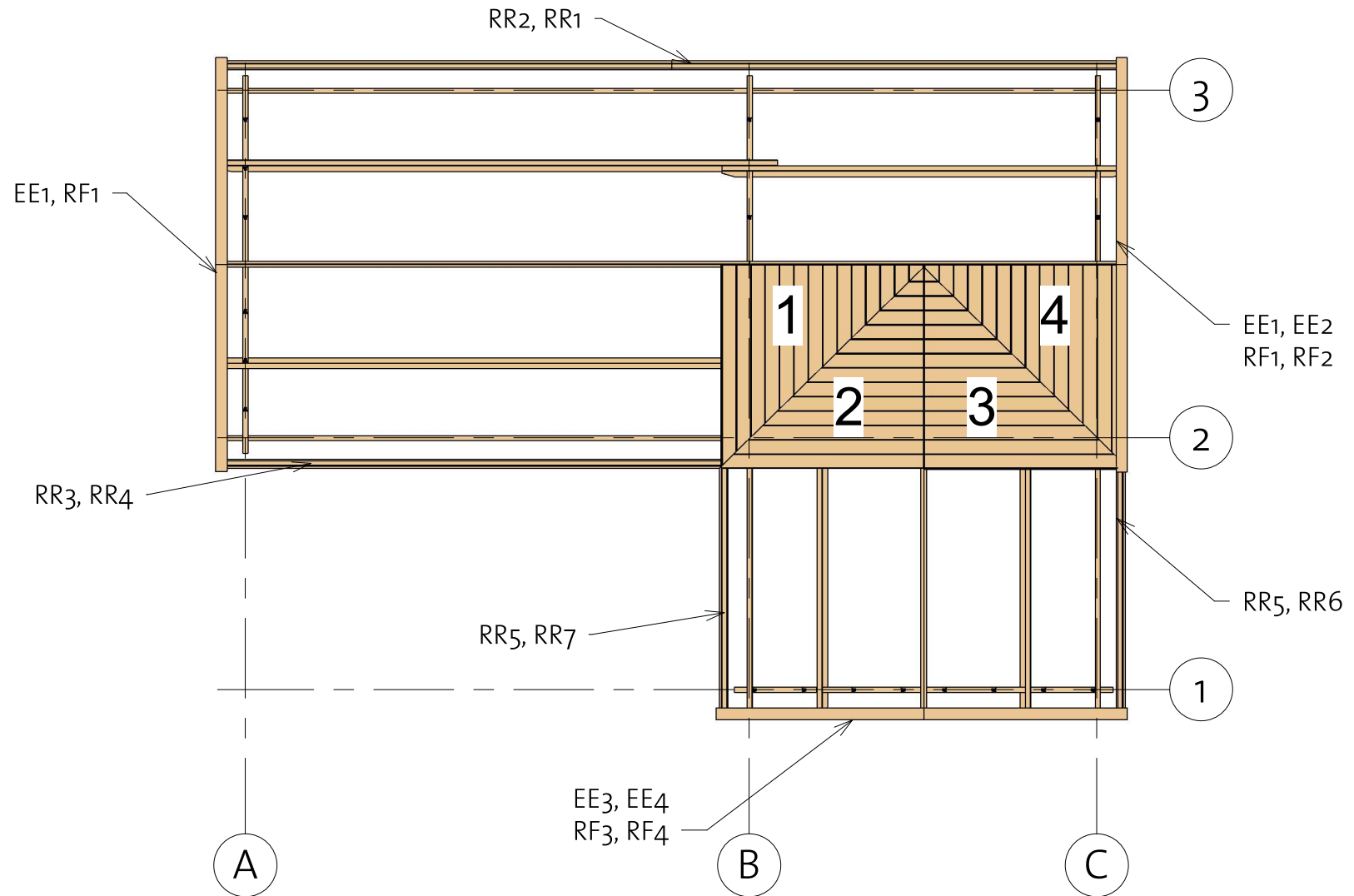

Parakenings 40 (680x480)

Roof 3

Roof Boards				
Mark	Type	Profile	Count	Length

RB1	17x114		102	1662
RB2	17x114		19	1664
RB3	17x114		19	1639
RB4	17x114		1	1659
RB5	17x114		1	1553
RB6	17x114		1	1436
RB7	17x114		1	1319
RB8	17x114		1	1202
RB9	17x114		1	1085
RB10	17x114		1	968
RB11	17x114		1	851
RB12	17x114		1	735
RB13	17x114		1	618
RB14	17x114		1	501
RB15	17x114		1	384
RB16	17x114		1	267
RB17	17x114		1	148
RB18	17x114		1	1664
RB19	17x114		1	1568
RB20	17x114		1	1448
RB21	17x114		1	1327

Roof Boards				
Mark	Type	Profile	Count	Length

RB22	17x114		1	1207
RB23	17x114		1	1086
RB24	17x114		1	966
RB25	17x114		1	845
RB26	17x114		1	724
RB27	17x114		1	604
RB28	17x114		1	483
RB29	17x114		1	363
RB30	17x114		1	242
RB31	17x114		1	122
RB32	17x114		1	1639
RB33	17x114		1	1576
RB34	17x114		1	1455
RB35	17x114		1	1335
RB36	17x114		1	1214
RB37	17x114		1	1094
RB38	17x114		1	973
RB39	17x114		1	853
RB40	17x114		1	732
RB41	17x114		1	612
RB42	17x114		1	491
RB43	17x114		1	371
RB44	17x114		1	250
RB45	17x114		1	129
RB46	17x114		1	1662
RB47	17x114		1	1545
RB48	17x114		1	1428
RB49	17x114		1	1311
RB50	17x114		1	1194
RB51	17x114		1	1078
RB52	17x114		1	961
RB53	17x114		1	844
RB54	17x114		1	727
RB55	17x114		1	610
RB56	17x114		1	493
RB57	17x114		1	376
RB58	17x114		1	259
RB59	17x114		1	142

Parakenings 40 (680x480)

Roof 4

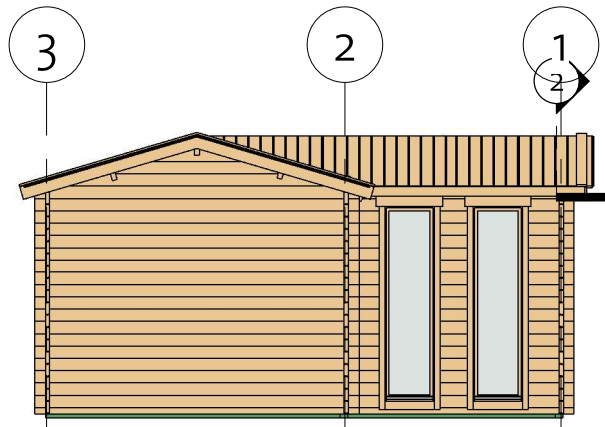

② Facia

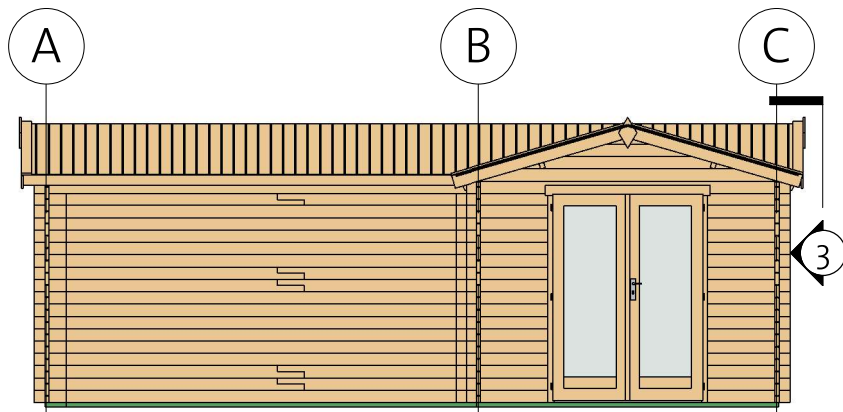
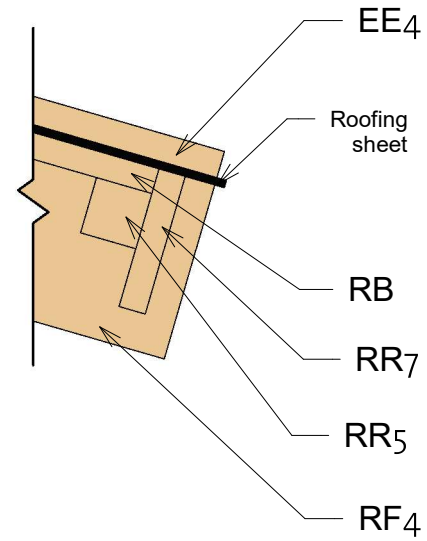



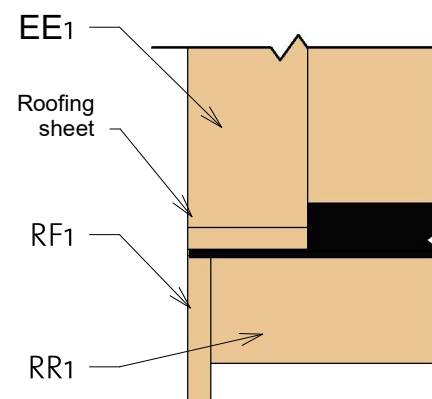

③ Roof Reinforcement









Parakenings 40 (680x480)

Roof 5





Fascia Schedule				
Mark	Type	Profile	Count	Length

EE1	Eave Edging 18x95		3	1706
EE2	Eave Edging 18x95		1	1710
EE3	Eave Edging 18x95		1	1682
EE4	Eave Edging 18x95		1	1707
RF1	Roof Fascia 18x120		3	1706

Fascia Schedule				
Mark	Type	Profile	Count	Length















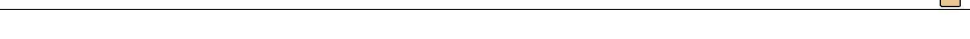
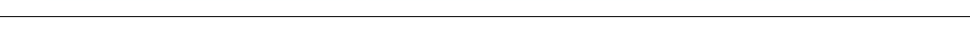
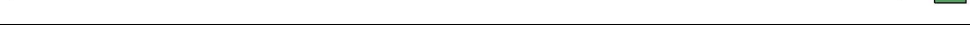



RF2	Roof Fascia 18x120		1	1710
RF3	Roof Fascia 18x120		1	1682
RF4	Roof Fascia 18x120		1	1707
RR1	Roof reinforce ment 18x95		2	3601
RR2	Roof reinforce ment 38x38		2	3601
RR3	Roof reinforce ment 38x38		1	3997

Fascia Schedule				
Mark	Type	Profile	Count	Length

RR4	Roof reinforce ment 18x95		1	4024
RR5	Roof reinforce ment 38x38		2	2000
RR6	Roof reinforce ment 18x95		1	1999
RR7	Roof reinforce ment 18x95		1	2026



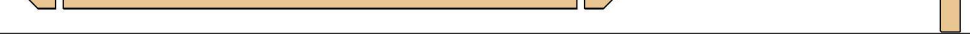













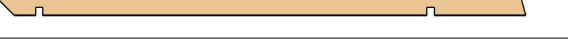





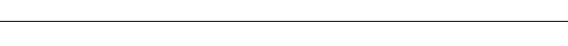
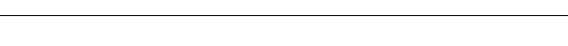







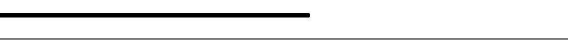

Parakenings 40 (680x480)

List of all items 1

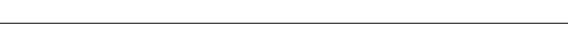
C	LG-2	Log 40x114		1	5100
B	LG-9	Log 40x114		1	5100
C	BL-1	HalfLog 40x57		1	5000
C	LG-1	Log 40x114		17	5000
	RFB1	Beam 45x155		1	4837
3	LG-3	Log 40x114		6	4750
	IFB1	IFB 70x40		1	4720
	IFB2	IFB 70x40		5	4650
	RFB2	Beam 45x170		1	4440
	RFR1	Ridge 45x170		1	4220
3	TL-2	Log 40x114		1	4220
2	TL-1	Log 40x114		1	4200
3	LG-2	Log 40x114		7	4120
3	LG-5	Log 40x114		5	4120
2	LG-8	Log 40x114		1	4120
	IFB3	IFB 70x40		1	3930
	RFR2	Ridge 45x165		1	3547
	RFB3	Beam 45x170		1	3203
A	BL-1	HalfLog 40x57		1	3000
A	LG-4	Log 40x114		18	3000
1	LG-6	Log 40x114		1	3000











Parakenings 40 (680x480)







List of all items 2

	RFR3	Ridge 45x170			1	2983
3	TL-1	Log 40x114			1	2983
3	LG-1	Log 40x114			12	2880
2	LG-6	Log 40x114			1	2880
	RFB4	Beam 45x155			1	2796
	RFB5	Beam 45x155			1	2796
	IFB4	IFB 70x40			1	2790
B	BL-2	HalfLog 40x57			1	2780
	IFB5	IFB 70x40			2	2720
	FB	FB 17x114			42	2714
3	LG-4	Log 40x114			6	2500
	RFB7	45x160			1	2254
	RFB8	45x160			1	2254
B	TL-1	Log 40x57			1	2208
C	TL-1	Log 40x57			1	2208
	RB2	17x114			19	1664
	RB1	17x114			102	1662
	RB3	17x114			19	1639
B	LG-5	Log 40x114			17	985
	RFB6	Beam 45x155			1	840
B	BL-1	HalfLog 40x57			1	780
1	LG-2	Log 40x114			34	780
B	LG-4	Log 40x114			17	780
B	LG-2	Log 40x114			17	445



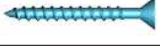

Parakenings 40 (680x480)















List of all items 3

	RFR4	Ridge 45x170			1	440
2	LG-9	Log 40x114			15	400
2	LG-10	Log 40x114			2	400
B	LG-1	Log 40x114			17	310
2	LG-2	Log 40x114			34	300
2	TL-2	Log 40x114			1	203
	IFB6	IFB 70x40			1	195

Hitblock	300-400 mm		
Bolts	M8x70		24
Screws	5,0 x 70		35
Nails	1,4 x 40		40
Dowels	16,0 x 150		50
Screws	6,0 x 140		100
Screws	4,0 x 40		1050

Romb	3	
------	---	---

BB1	BB 20x40			2	2800
BB2	BB 20x40			2	5000

RR3	Roof reinforcement 38x38			1	3997
RR4	Roof reinforcement 18x95			1	4024
RR1	Roof reinforcement 18x95			2	3601
RR2	Roof reinforcement 38x38			2	3601
RR5	Roof reinforcement 38x38			2	2000
RR7	Roof reinforcement 18x95			1	2026
RR6	Roof reinforcement 18x95			1	1999
EE2	Eave Edging 18x95			1	1710
RF2	Roof Fascia 18x120			1	1710
EE4	Eave Edging 18x95			1	1707
RF4	Roof Fascia 18x120			1	1707
EE1	Eave Edging 18x95			3	1706
RF1	Roof Fascia 18x120			3	1706
EE3	Eave Edging 18x95			1	1682
RF3	Roof Fascia 18x120			1	1682

Windboard 18x40			8	2200
--------------------	---	--	---	------

200420

Parakenings 40 (680x480)

List of all items 4

CDD3R	Classic double door 3, full glass right	1425	1955	2
-------	---	------	------	---

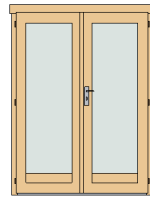

* Windows intended for tilt opening only!
 * Fenster zur Eröffnung nur zum Kippen vorgesehen!
 * Aknad on ette nähtud ainult kaldu avamiseks!

CW21R	Classic window 21 right	515	1890	2
-------	-------------------------	-----	------	---

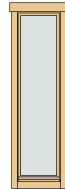

① Gable 1

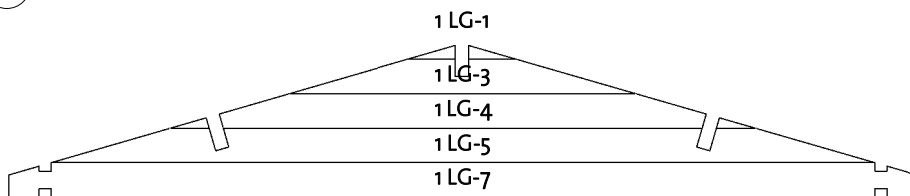

② Gable 2

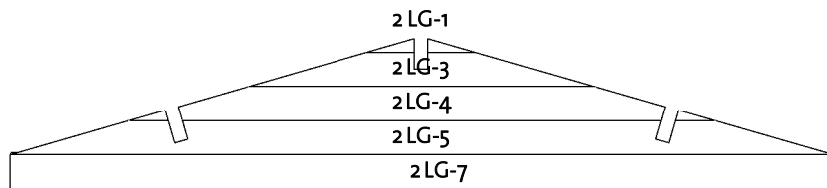

③ Gable A

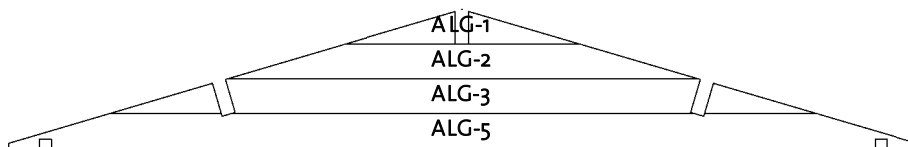

④ Gable B

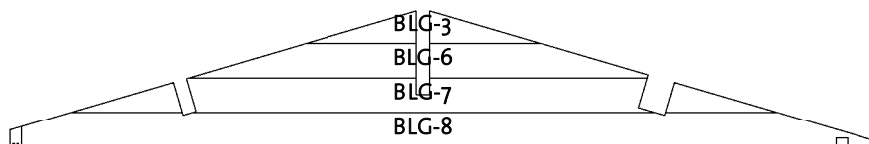

⑤ Gable C

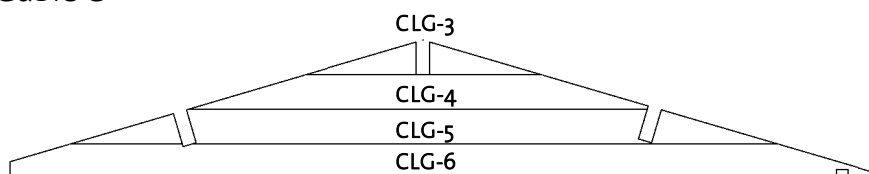

Parakenings 40 (680x480)

List of all items 5

① RB 4x14 boards

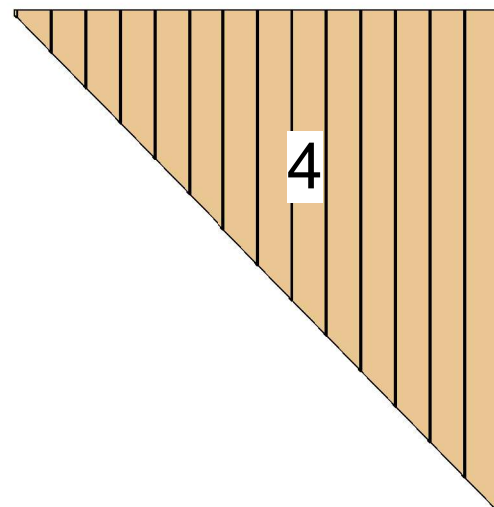
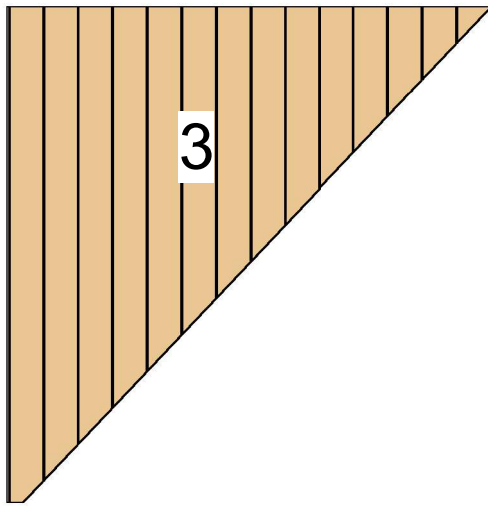
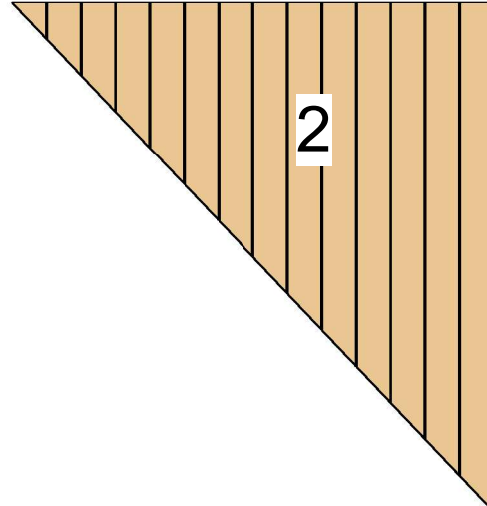
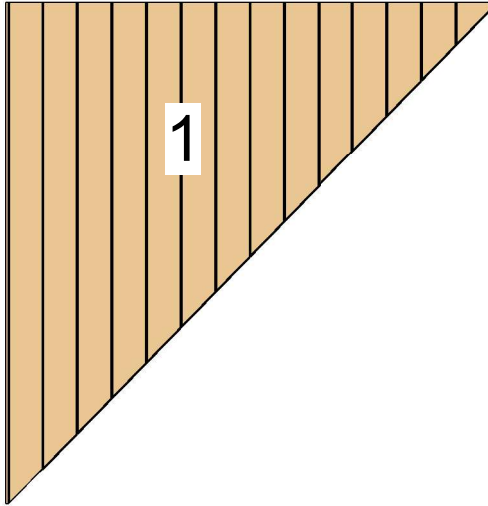

Windboard

① Windboard Assembly 1



② Windboard Assembly 2

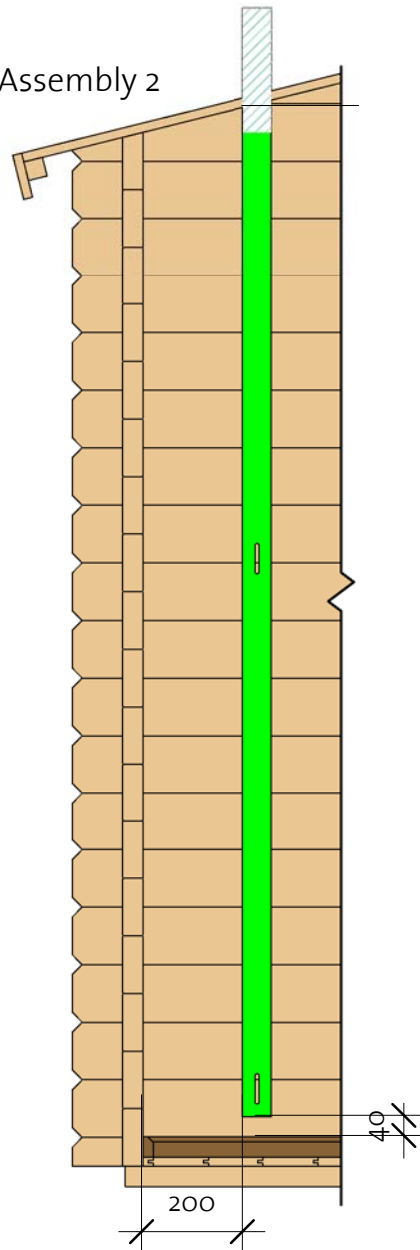

③ Windboard Assembly 3

